

# HERZ 4-way thermostatic valve HERZ for use in one- and two-pipe heating systems used to connect sectional and tubular radiators

Datasheet for VTA, VUA, Issue 1122

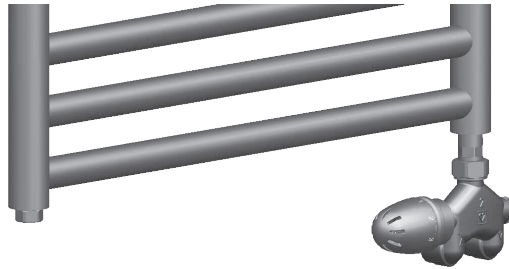

Assembly connection HERZ VTA series connection horizontally bottom side



Assembly connection HERZ VTA series connection vertical bottom side



HERZ cover for VTA valves

## ☑ Versions

**7767** HERZ-VTA-40-Four-Way Valve **7783** Herz VUA 40 Four-Way Valve **7783** Herz VUA-AHA Four-Way Valve  
**7767 H** HERZ-VTA-50-Four-Way Valve **7783 H** Herz VUA 50 Four-Way Valve  
**7784** Herz VUA 40 Four-Way Valve  
**7784 H** Herz VUA 50 Four-Way Valve  
**7786** Herz VUA 40 Four-Way Valve  
**7786 H** Herz VUA 50 Four-Way Valve

Valve housing made of brass, nickel plated, EPDM seals, spindle seal by means of O-ring, TS-upper parts sealed EPDM O-ring, RL-1-upper parts metal seated.

All models are supplied with screw caps. They can be equipped with a HERZ-thermostat at any time without draining the system.

**It is necessary to pay attention on matching of the thread of the thermostatic valve with thermostatic head**

## ☑ Field of Application

One- and two-pipe water heating systems with calibrated soft steel, copper or plastic pipes.

## ☑ Operating data

Maximum operating temperature	120 °C
Maximum operating pressure	10 bar
Max. pressure difference at thermostaic valve	0,2 bar
Hot water purity in accordance with Austrian standard ÖNORM H 5195 and/or VDI-guideline 2035.	

One-pipe system

Max. Pressure at the pressure test or after radiator dismounting	5 bar
--	-------

Ammonia contained in the packing yarn may cause damage of the body of the valve. The thread of the union nut must be lubricated with silicone oil during assembly. Mineral oil would destroy the O-ring of the olives.

Frost and corrosion protection agents based on ethylene glycol are permitted in a volume proportion of 25 ÷ 50% with water. For further information please refer to the data sheets of the manufacturer.

When using HERZ compression adapters for copper and steel pipes, observe the permissible temperatures and pressures as in EN 1254-2:1998 Table 5. The plastic pipe connections are suitable for application classes 4 and 5 according to ISO 10508 (panel heating and radiator connection) and for pipes made of PE-RT (EN ISO 22391), PP (EN ISO 15874), PB (EN ISO 15876) und PE-X (EN ISO 15875). This results in a maximum operating temperature of 95 °C at 10 bar. It is up to the user to select the operating pressure and temperature for the respective pipe type so that the standard values and the permissible operating data of the manufacturer are adhered to.

#### ☑ Material

Pursuant to Article 33 of the REACH Regulation (EC No. 1907/2006), we are obliged to point out that the material lead is listed on the SVHC list and that all brass components manufactured in our products exceed 0.1 % (w / w) lead (CAS: 7439-92-1 / EINECS: 231-100-4). Since lead is a component part of an alloy, actual exposure is not possible and therefore no additional information on safe use is necessary.

#### ☑ Preliminary Installation

HERZ-VTA-valves permit the laying of the piping, installation of the valves, and pressure testing before radiators are installed.

#### ☑ Radiator Connection VTA-40 / 50, VUA-40 / 50

Connection R 1/2" or R 3/4" respectively installed. Radiator screw connection with submerged pipe. The connection with flat seal and the submerged pipe which can be detached make radiator installation easy. The radiator need not be drawn over the submerged pipe. Damage and installation complications in narrow niches are avoided. Submerged pipe enters the distribution chamber, which ensures optimal distribution of the water in the radiator. To prevent the flow of medium in the return flow in radiators, air vents must be installed. Threaded connector can be attached to the appropriate radiator coupling.

#### ☑ Threaded connection VUA-AHA

Valve body with connection thread G 3/4 flat seal was developed to replace T&A AHA four-way valves. The immersion tube is integrated in the valve. The flat-sealing connection enables easy installation to the radiator. Pipe connections G 3/4" with cone must be ordered separately.

#### ☑ Labeling the various versions



Body of the valve is labeled with:

„1“ - four way valve for one pipe systems

„2“ - four way valve for two pipe systems

Valves without code are reversible from two to one pipe systems

#### ☑ Mounting of Compression Unions onto the Pipe

When mounting the compression unions do not use adjustable pliers or any similar tools since this will result in deformation of the union nut. Steel and copper pipes must be properly calibrated and deburred. It is recommended to use support sleeves. The thread of the union nut must be lubricated with silicone oil during assembly. Mineral oil would destroy the O-ring of the olives. The mounting instructions enclosed with the compression unions must be observed.

#### ☑ Compression Unions

- 6274** Compression adapter for soft steel and copper pipes.
- 6276** Compression adapter with soft seal for copper pipes. Outside pipe diameter 12, 14, 15, 16 and 18 mm.
- 6098** Plastic pipe connections for PE-X, PB and aluminium composite pipes.  
Dimensions and order numbers can be found in the HERZ product range.
- 6284** Compression adapters for soft steel and copper pipes  
Outside pipe diameter 10, 12, 14, 15, and 16 mm
- 6286** Design-Compression adapter 12, 15 mm
- 6066** Design-Compression adapter for PE-X, PB and aluminium composite pipes  
Outside pipe diameter 14 x 2, 16 x 2, 17 x 2 mm.

☑ **Standard DIN V3838 „Eurokonus“, connection thread G 3/4 A with inner cone**

As the recommended standard DIN V 3838 before the adoption of the final version may change and until a time has not yet set when all the products will conform to these standards, you should avoid combining products from different manufacturers when connecting valves and fittings.

HERZ offers an extensive program of pipes and connections ensures that all fittings and HERZ connection fittings are always compatible with HERZ. In addition, HERZ can not hold responsibility for the products of other manufacturers, and therefore can not give any guarantees for combining products with the products of other manufacturers.

☑ **Steel pipes connection according to DIN 2440**

Four-way valves can be connected to a HERZ steel pipes according to DIN 2440 using the 6223 connector.

☑ **Water Distribution in One-Pipe Systems**

At nominal valve lift, 40% of the water flow is through the radiator and 60% through the bypass element. The incorporated regulating and shutoff screw permits hydraulic balancing in thermostatic operation and/or shutting off within the radiator.

☑ **HERZ-Thermostatic Valve  
Nominal Lift**

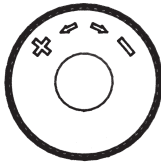

The screw cap serves for operation during the installation phase (pipe flushing). The thermostatic function is activated by removing the screw cap and screwing in the HERZ-thermostatic head without draining the heating system.

Setting the nominal lift with the screw cap:

On the knurled part of the circumference of the screw cap there are two setting marks (webs) in alignment with the “+” and “-” marks.

1. Close the valve by turning the screw cap clockwise.
2. Mark the position corresponding to the setting mark “+”.
3. Turn the screw cap anti-clockwise until the setting mark “-” is at the position marked under item 2.

☑ **Thermostat Installation instructions**

If radiators and thermostatic valve covered (curtains, paneling) to form a heat accumulation zone in which the thermostatic element sensing the room temperature does not feel and can not regulate. In these cases, the HERZ thermostatic be used with remote sensor or remote control. For details on HERZ-thermostats refer to the product standard sheets.

☑ **HERZ-TS Hand Wheel**



In the exceptional case that the valve is not equipped with a HERZ-thermostatic head, a HERZ-TS hand wheel is mounted to replace the screw cap.

**9102** HERZ-TS-90-Hand wheel, Series 9000 „Design“

☑ **Summer Setting**

After the end of the heating period open the valve completely by turning it in an anti-clockwise direction to prevent dirt deposits at the valve seat.

☑ **Changing the Thermostatic Upper Part**

The thermostatic upper part can be changed by means of the HER tool while the system is under pressure:

- To change the thermostatic upper part in order to remedy defects caused by foreign substances such as dirt, welding or soldering residues.
- In case of two-pipe systems: for retrofitting with thermostatic upper parts with fixed, stepped, kv-values or with presetting function. This permits adaptation of the radiator flow rate to individual requirements.

**☑ Removing the radiator**

After locking of the thermostatic upper parts radiator can be removed without draining the system. Before disassembly, drain the water from the radiator.

- VUA Valve regulating stem locking is made with HERZ multi-purpose key (1 6625 00)
- VTA Allen key SW 8. Under the complete rotation valve opening is reaching after 3 ... 3.5 turns of the key.

**☑ Flexible X-Shaped**

**Intersection Element**

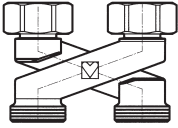

This special connection element is installed between the valve and piping for the adaptation of distances between pipes and for radiator adaptation. For details refer to the standard sheet **3004**.

**☑ Changing the O-Ring Chamber**



1. Remove the HERZ-thermostatic head or HERZ-TS-hand wheel.
  2. Unscrew the O-ring chamber with the O-ring and replace with a new one. During this change use a wrench to hold the upper part. After removal of the thermostatic head or hand wheel the valve is completely open and therefore sealed tight towards upstream. However, a few drops of water may leak out.
  3. For re-assembly follow the above steps in reverse sequence.
- Order number of HERZ-TS-90-O-ring set: 1 **6890 00**

**☑ Order Numbers**

**VTA 40** Four-Port Valves for Thermostatic, Connection M28 x 1,5 - Pipe centre distance 40 mm Pipe connections have to be ordered separately.

- 1 **7767 41** R=1/2 for one-pipe system, with dip tube l = 200 mm, Ø = 11 mm
- 1 **7767 42** R=3/4 for one-pipe system, with dip tube l = 200 mm, Ø = 11 mm
- 1 **7767 51** R=1/2 for two-pipe system, with dip tube l = 200 mm, Ø = 11 mm
- 1 **7767 52** R=3/4 for two-pipe system, with dip tube l = 200 mm, Ø = 11 mm

**VTA 50** Four-Port Valves for Thermostatic, Connection M30 x 1,5 - Pipe centre distance 50 mm Pipe connections have to be ordered separately.

- 1 **7767 26** R=1/2 for one-pipe system, with dip tube l = 200 mm, Ø = 11 mm
- 1 **7767 27** R=1/2 for two-pipe system, with dip tube l = 200 mm, Ø = 11 mm

**☑ Kv values for two pipe system**

p - proportional band [K]	kv-value							
	0,5	1	1,5	2	2,5	3	3,5	4
<b>Preset</b>								
<b>1</b>	0,03	0,03	0,03	0,03	0,03	0,03	0,03	0,03
<b>2</b>	0,05	0,05	0,05	0,05	0,05	0,05	0,05	0,05
<b>3</b>	0,08	0,09	0,09	0,09	0,09	0,09	0,09	0,09
<b>4</b>	0,12	0,15	0,15	0,15	0,15	0,15	0,15	0,15
<b>5</b>	0,14	0,19	0,20	0,20	0,20	0,20	0,20	0,20
<b>6</b>	0,14	0,23	0,24	0,25	0,25	0,25	0,25	0,25
<b>7</b>	0,15	0,28	0,31	0,32	0,32	0,32	0,32	0,32
<b>8</b>	0,16	0,31	0,38	0,40	0,41	0,42	0,42	0,42
<b>9</b>	0,17	0,32	0,45	0,55	0,63	0,67	0,69	0,71

Flow distribution for one pipe system

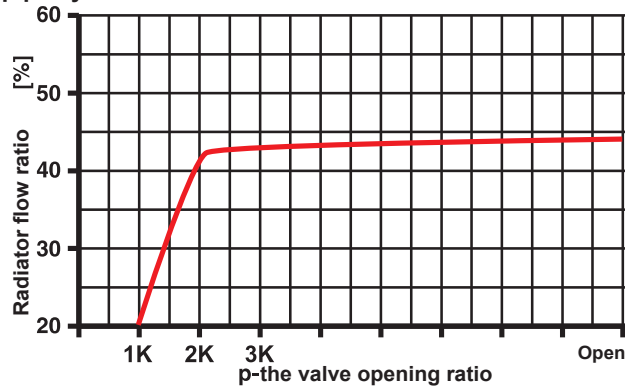

p-proportional band [K]	kv-value							
	0,5	1	1,5	2	2,5	3	3,5	4
VTA One pipe	0,15	0,31	0,46	0,60	0,75	0,81	0,82	0,83

Accessories

- 1 3004 34 Intersection Element in "X"-shape Pipe centre distance 50 mm, connection with cone seal G 3/4.
- 1 6248 01 Connection elbow 90°
- 1 6625 00 HERZ-Multi-Purpose Key
- 1 6807 90 HERZ-TS-90 - Installation Key
- 1 6822 40 Double rosette centre pipe distance 40 mm
- 1 7780 00 HERZ-Changefi x Tool for HERZ-Thermostatic Upper Parts M 28 x 1,5 mm
- 1 7780 98 HERZ-Changefi x Tool for HERZ-Thermostatic Upper Parts M 30 x 1,5 mm

Replacement parts

- VTA 40 two-pipe 1 6367 98 with pre-setting
- VTA 40 one-pipe 1 6390 91 without pre-setting 1 6390 92 without pre-setting
- VTA 50 two-pipe 1 6398 98 with pre-setting
- VTA 50 one-pipe 1 6398 91 without pre-setting

Versions. Order numbers

- VUA 40** VUA-40-Four-Port Valves for Thermostatic Operation, Connection M 28 x 1,5 Pipe centre distance 40 mm Pipe connections have to be ordered separately.
- 1 7783 41 R=1/2 Four-Port Valve Straight model for two-pipe system l = 150 mm, Ø = 11 mm
  - 1 7783 51 R=1/2 Four-Port Valve Straight model for two-pipe system l = 200 mm, Ø = 11 mm
  - 1 7784 41 R=1/2 Four-Port Valve Angle model for two-pipe system l = 150 mm, Ø = 11 mm
  - 1 7784 42 R=1/2 Four-Port Valve Angle model for two-pipe system l = 150 mm, Ø = 11 mm
  - 1 7786 41 R=1/2 Four-Port Valve Straight model for one-pipe system l = 150 mm, Ø = 11 mm
  - 1 7786 51 R=1/2 Four-Port Valve Straight model for one-pipe system l = 200 mm, Ø = 11 mm
- VUA 50** Four-Port Valves for Thermostatic Operation, Connection M 30 x 1,5 Pipe centre distance 50 mm Pipe connections have to be ordered separately.
- 1 7786 26 R=1/2 Four-Port Valve Straight model for one-pipe system l = 200 mm, Ø = 11 mm
  - 1 7783 26 R=1/2 Four-Port Valve Straight model for two-pipe system l = 200 mm, Ø = 11 mm
  - 1 7784 62 R=1/2 Four-Port Valve Angle model for one-pipe system l = 150 mm, Ø = 11 mm
  - 1 7784 61 R=1/2 Four-Port Valve Angle model for two-pipe system l = 150 mm, Ø = 11 mm
- VUA-AHA** VUA-40-Four-Port Valves for Thermostatic Operation, connection M 28 x 1,5, pipe centre distance 40mm, Replacement for T&A- AHA four-port valves, radiator connection on lower middle or on side from below Pipe connections have to be ordered separately.
- 1 7783 40 G=3/4 Four-Port Valve Straight model for one-pipe system, Immersion tube length l=55 mm, Ø=11 mm

Kv values for two pipe system

p-proportional band [K]	kv-value							
	0,5	1	1,5	2	2,5	3	3,5	4
<b>Preset</b>								
<b>1</b>	0,05	0,11	0,14	0,14	0,14	0,14	0,14	0,14
<b>2</b>	0,13	0,25	0,29	0,30	0,30	0,30	0,30	0,30
<b>3</b>	0,14	0,26	0,38	0,42	0,44	0,44	0,45	0,45
<b>4</b>	0,14	0,27	0,39	0,50	0,54	0,55	0,56	0,57
<b>5</b>	0,15	0,28	0,40	0,53	0,66	0,70	0,72	0,73
<b>6</b>	0,15	0,28	0,41	0,56	0,70	0,76	0,80	0,81

Flow distribution for one pipe system

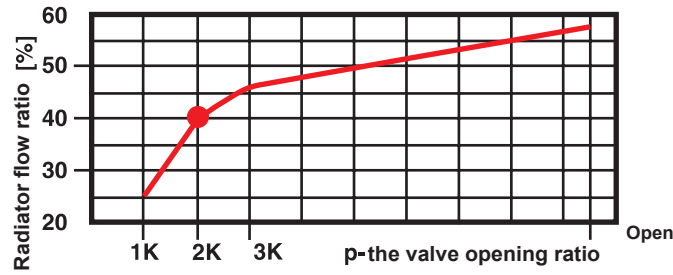

	kv-value							
p-proportional band [K]	0,5	1	1,5	2	2,5	3	3,5	4
VUA one pipe	0,15	0,31	0,46	0,60	0,75	0,81	0,82	0,83

Accessories

- 1 **3004 34** Intersection Element in "X"-shape Pipe centre distance 50 mm, connection with cone seal G 3/4.
- 1 **6248 01** Connection elbow 90°
- 1 **6625 00** HERZ-Multi-Purpose Key
- 1 **6807 90** HERZ-TS-90 - Installation Key
- 1 **6822 40** Double rosette centre pipe distance 40 mm
- 1 **7780 00** HERZ-Changefi x Tool for HERZ-Thermostatic Upper Parts M 28 x 1,5 mm
- 1 **7780 98** HERZ-Changefi x Tool for HERZ-Thermostatic Upper Parts M 30 x 1,5 mm

Replacement parts

- VUA 40 two pipe 1 **6367 98** with pre-setting 1 **6390 91** without pre-setting
- VUA 40, VUA-AHA one pipe 1 **6390 92** without pre-setting
- VUA 50 two pipe 1 **6398 98** with pre-setting 1 **6398 91** without pre-setting
- VUA 50 one pipe 1 **6398 92** without pre-setting
- 1 **6890 00** HERZ-TS-90 Compression gland-set

Installation dimensions in mm

VTA 40/50 R = 1/2"

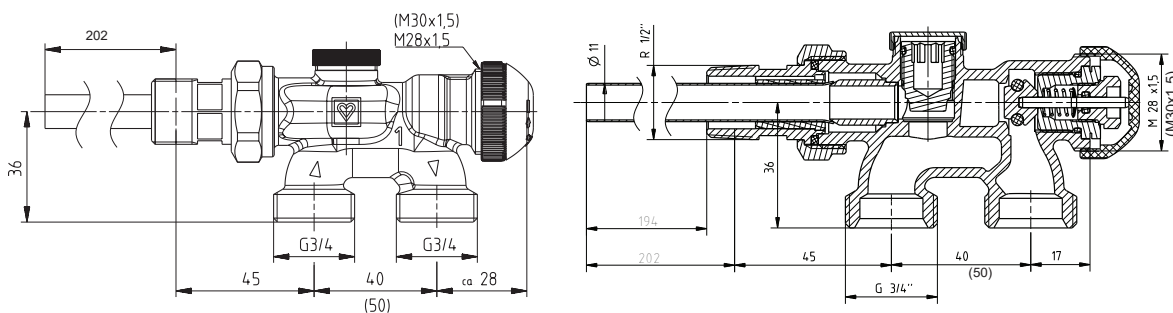

VTA 40 R = 3/4"

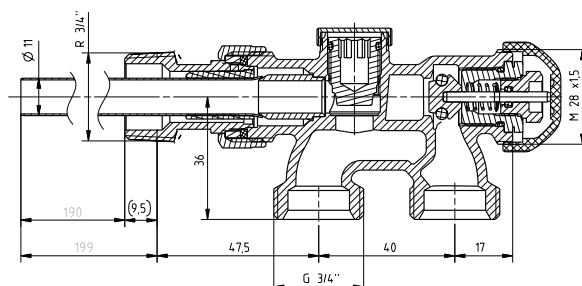

**VUA 40 / 50 R = 1/2"**

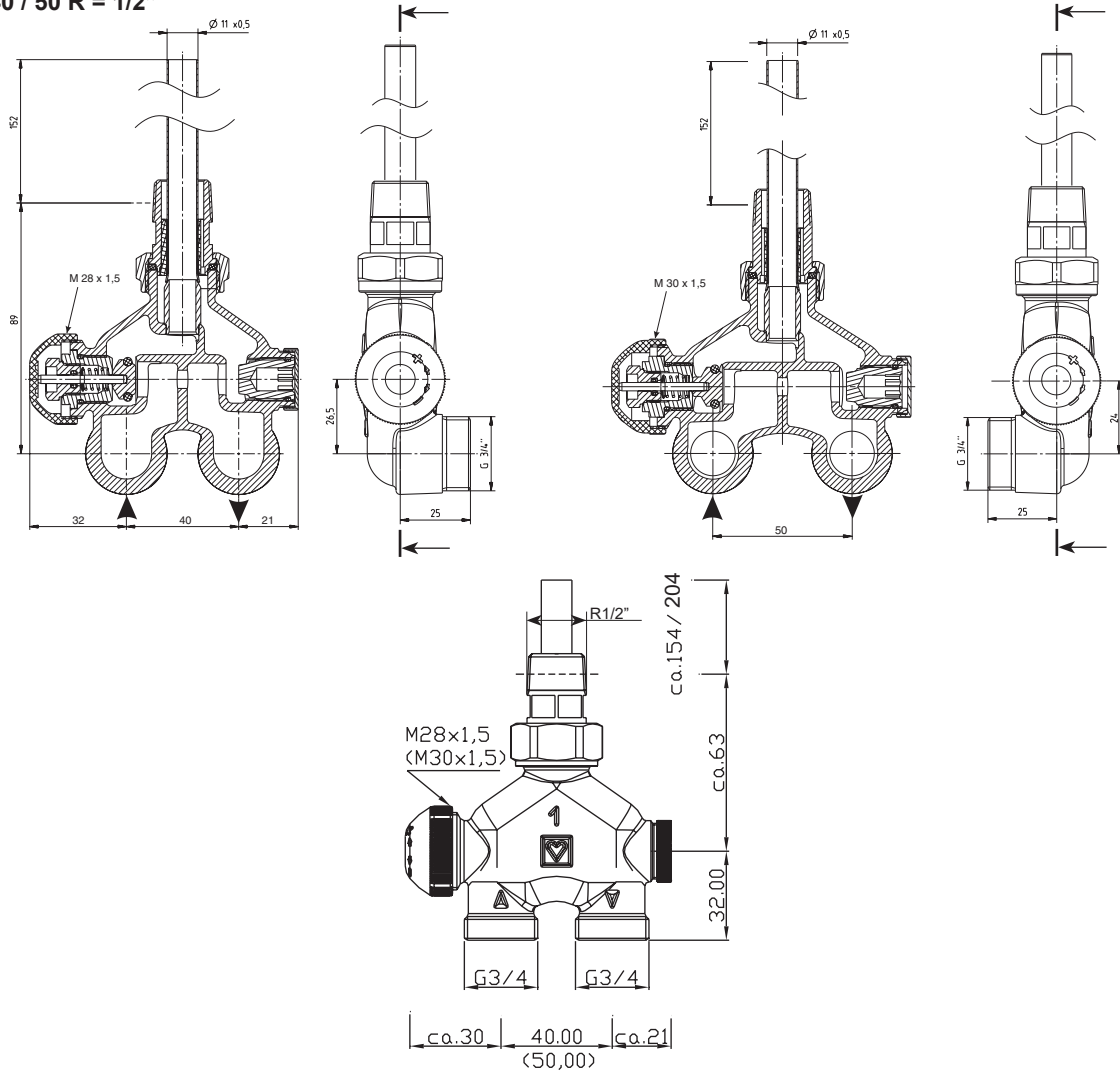

**VUA-AHA G = 3/4"**

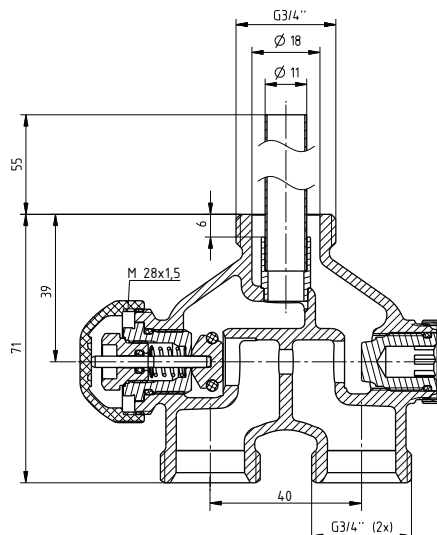

**Disposal**

Local and currently applicable legislation must be observed for disposal. The disposal of HERZ four way valves must not endanger the health or the environment.

Please note: all diagrams are indicative in nature and do not claim to be complete. All specifications and statements within this document are according to information available at the time of printing and meant for informational purpose only. Herz Armaturen reserves the right to modify and change products as well as its technical specifications and/or its functioning according to technological progress and requirements. It is understood that all images of Herz products are symbolic representations and therefore may visually differ from the actual product. Colours may differ due to printing technology used. In case of any further questions don't hesitate to contact your closest HERZ Branch-office.

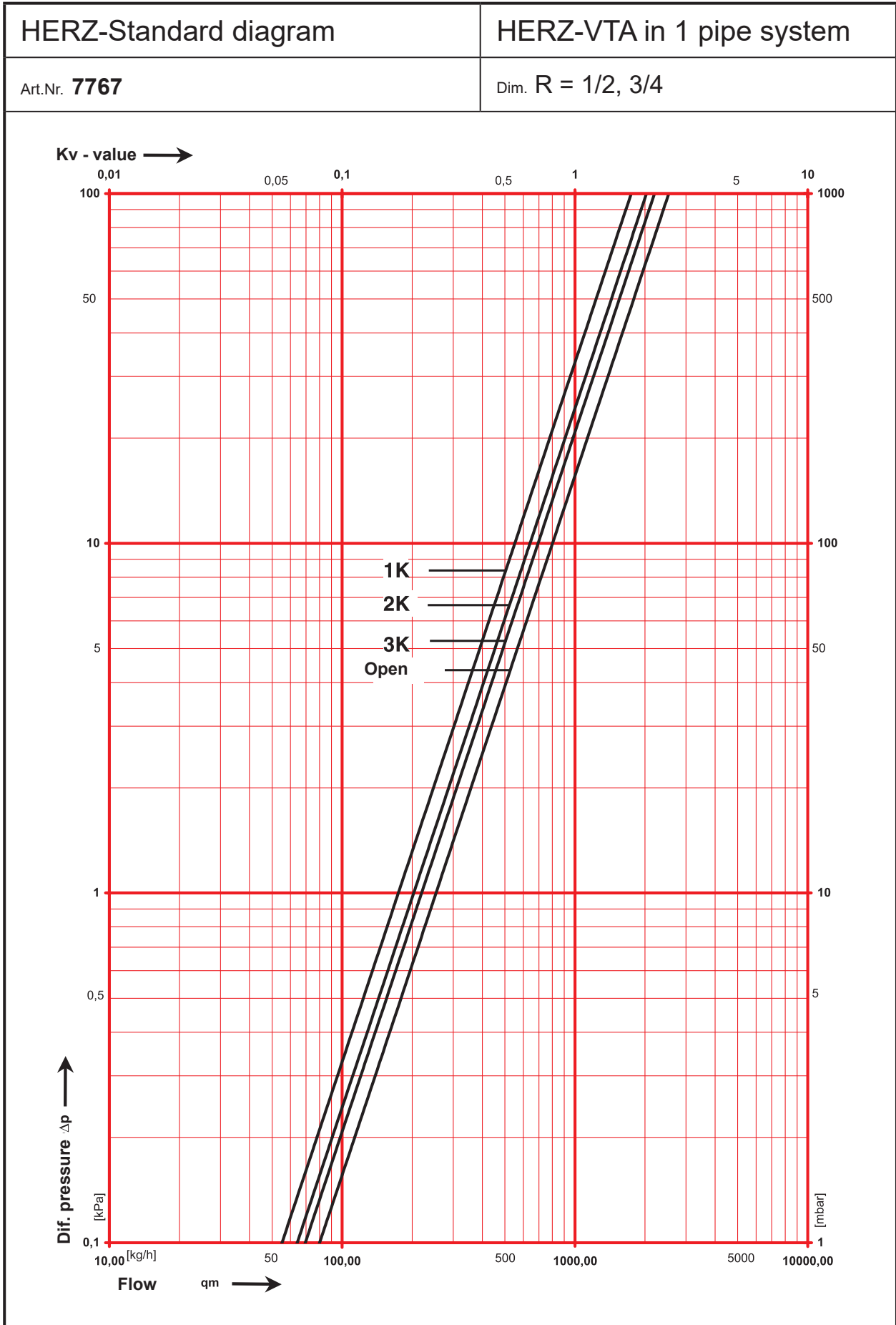



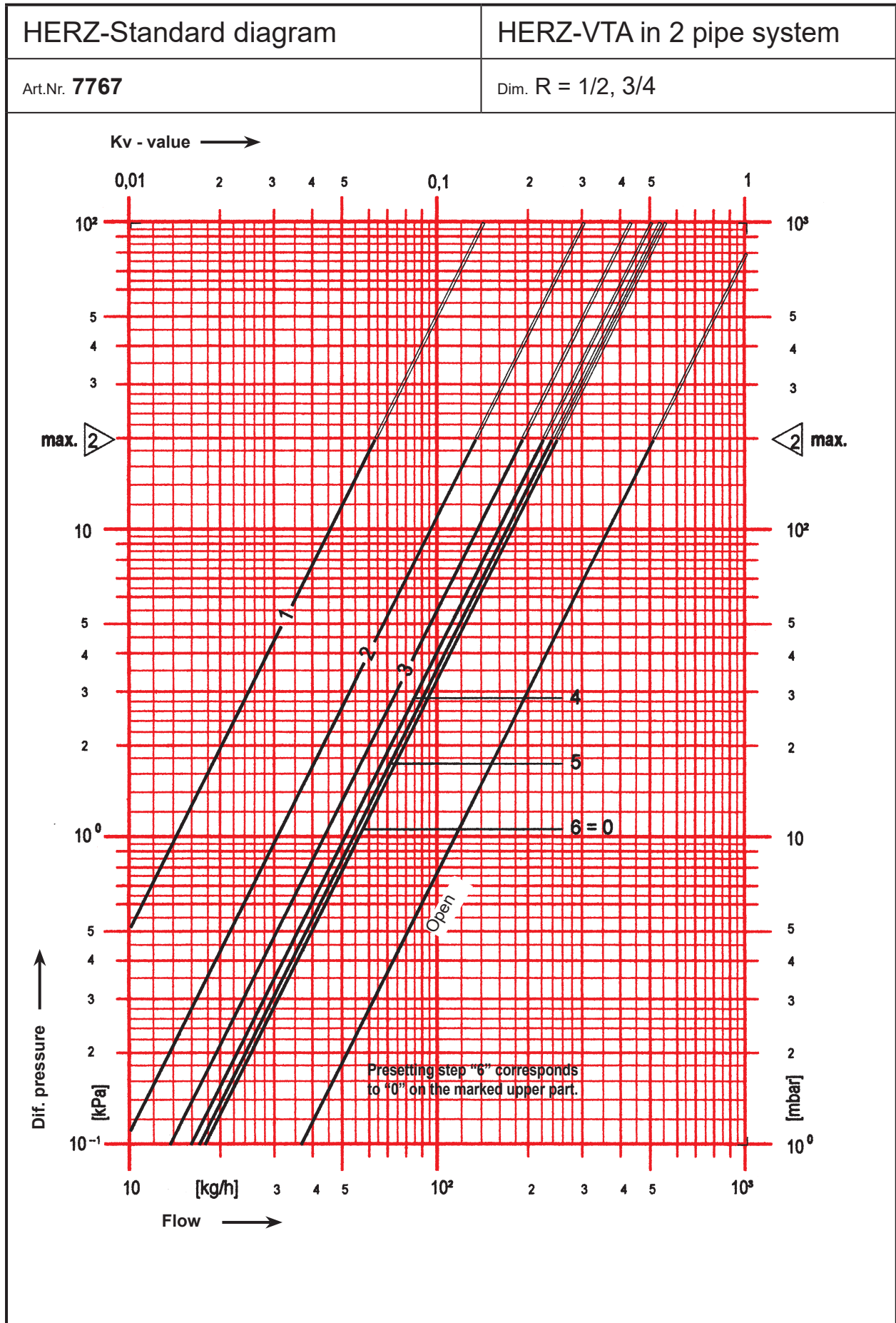

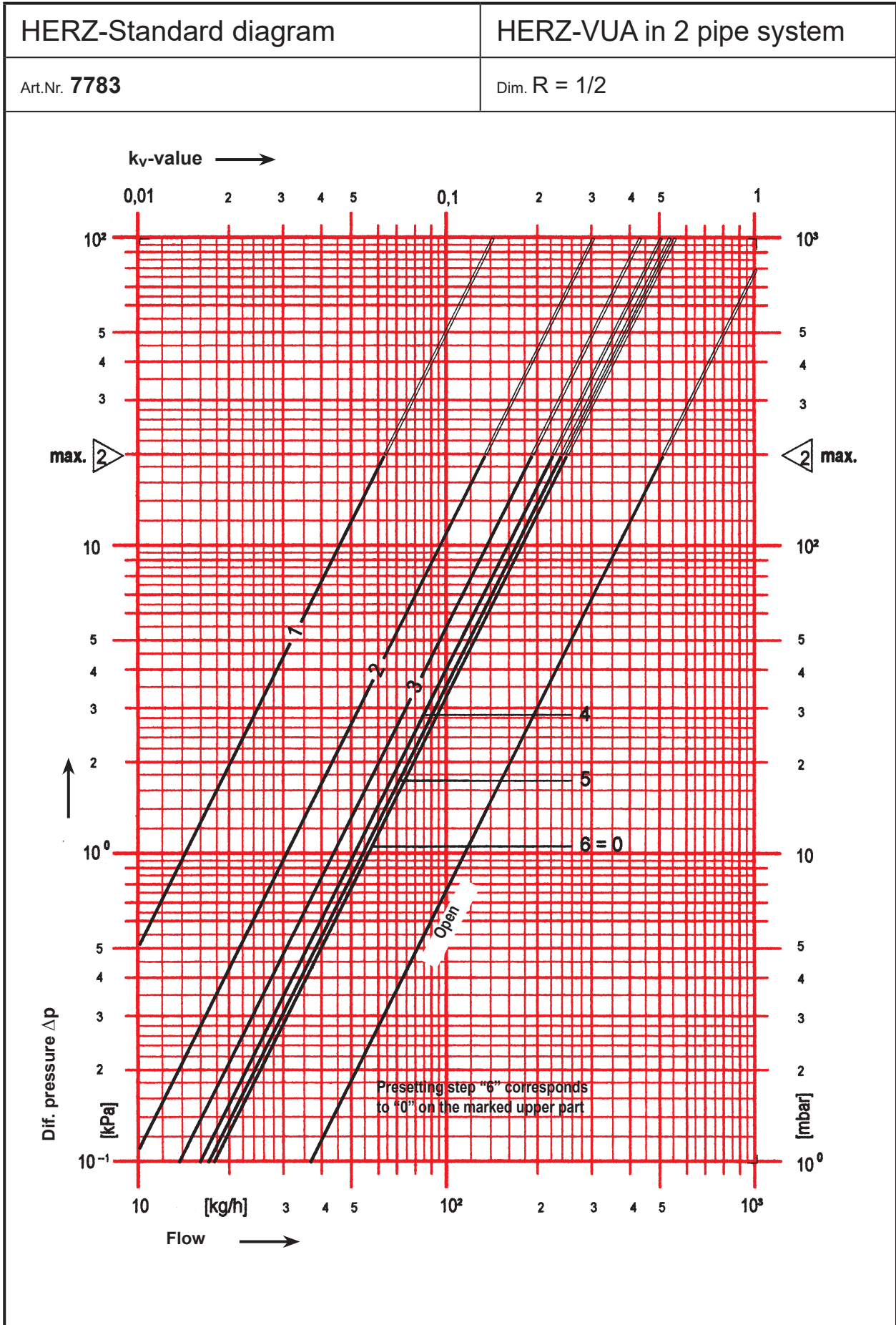

HERZ-Standard diagram	HERZ-VUA in 1 pipe system
-----------------------	---------------------------

Art.Nr. <b>7786, 1 7783 40</b>	Dim. R = 1/2, G = 3/4
--------------------------------	-----------------------

